

Auper Electronic Controls Inc

Eclipse 4250 IE

Quick User Guide



INSTALLATION

1. Connect the network cable to the Eclipse. This cable will be used to communicate to the computer and the Liquor Manager Live software.
2. If you plan on connecting the Eclipse system to a serial printer, a PC or a POS system, install the communication cable and test it before securing the system under the bar.
3. Connect the power supply cord to the 20 VA, 24 volts AC transformer. We recommend using a battery backup with surge protector as a precaution.
4. Mount your Eclipse system under the bar where bartenders make the drinks close to the bottles they will be using most. If you can, try to stay **away from where liquor spills** could fall onto the Eclipse. Apply a strip of silicone to prevent liquid spills from finding their way between the countertop and the machine all the way to the connectors infiltrating the back and connectors.

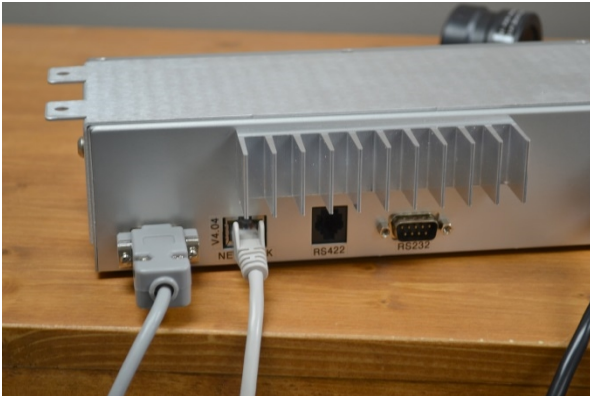

5. **Mount the activator ring holder to the right of the system** (Most people are right handed) where it is most convenient for bartenders.
6. **Soft drink bar guns should be mounted on the left of the system.**
7. **Avoid mounting the ring above a sink where it could fall in water.**
8. Secure your activator ring cable to the ring holder using a cable tie (see photo).

NETWORK CONNECTION

Plug the other end of the network cable into a network port of your POS computer network. If there is no available port, use a small 5-port Ethernet switch to add some.

1. Connect the Ethernet switch to the power.
2. Disconnect the POS terminal from the network port.
3. Connect the switch to the port using a network cable.
4. Connect the POS terminal into the network switch.
5. Make sure the POS network is set to access the Internet.

Interfacing the Eclipse 4250 to the Liquor Manager Live software is faster (115Kbytes/sec) and without risk of data collisions using the network port.

CONNECTING THE ECLIPSE TO A SERIAL PRINTER

To connect a serial printer to the Eclipse, use the RS-232 port. The 9-pin female serial cable supplied with the printer is directly compatible.

Set the RS-232 port to printer. (See programming)

Printer settings

- Baud rate: 9600
- Parity: none
- Stop bit: 1
- Handshaking: Xon/Xoff
- Print columns: 40



PROGRAMMABLE POURERS



Each pourer contains an electronic chip in which you will program a number between 0 and 255. Each pourer number relates to a brand name programmed in the Eclipse. You can program as many pourers as you need with the same number. You will use the Eclipse activator ring to program the numbers when you install the system.

Installation

The Eclipse system is normally preset with the brand names, portion sizes and prices associated with each pourer number. We send a configuration print out with the system which you will use as a reference. The pourer number associated to each brand is on the list.

We program the brands in alphabetical order and leave unassigned numbers between each letter to leave room should you want to add some products in the future.

You receive the non-programmed pourers in bags of 25. You will program the number just before you install the pourer on the bottle. We recommend you follow the alphabetical order on the list. The pourer numbers to program will increment slowly and you will only have to increase the number you need to program after each bottle.

INSERTS

The pourers are provided with an insert that fits a good number of bottlenecks. Unfortunately, it doesn't fit all of them. Some brands have a smaller bottleneck. These will require adjustments. A few ones have a bigger bottleneck. You will need to exchange the insert for a larger one.

If the insert provided with the pourer is too loose, liquor will leak between the pourer and bottleneck.

If the insert is too tight, you will not be able to push the pourer in all the way in and it will be hard to remove it from an empty bottle which can lead to the breather tube being pulled out landing at the bottom of the empty bottle. Since the pourer is always going back on the same brand, you do this only once.

To cut the fins of the insert, use a cutter or a nail clipper.

Start with the top fin and insert the bottle to see how it fits.

Cut a second or third fin if needed.



PROGRAMMING POURER NUMBERS AND INSTALLING THEM ON BOTTLES

1. Power up the Eclipse 4250.
2. Press and hold the P1 button as you apply the ibutton key.
3. Release P1 and remove the ibutton as soon as the F button turns red.
4. "TAG" refers to the RFID chip inside the pourer.
5. 000 is the number you will program into the Tag.
6. Use the left and right arrow buttons to move the cursor.
7. Use P1 to increase the number and P2 to decrease it.
8. If you are on number 9 and press P1, the next number will be 10.
9. Insert the pourer into the activator ring to program the number.
10. Press P4 to program it.
11. The number appears at the bottom of the screen.
12. To exit the program mode when finished, apply the ibutton until the F button red light goes off.

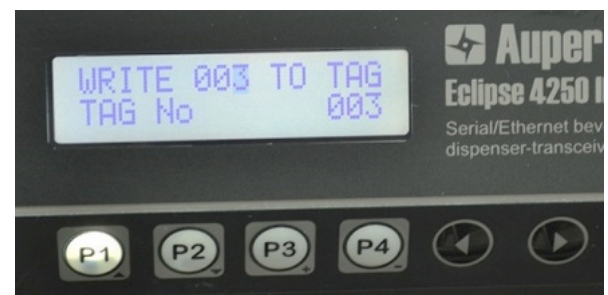
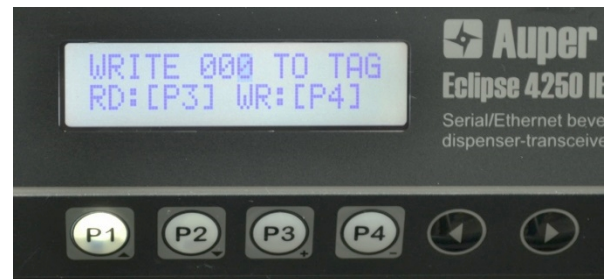

13. Insert the programmed pourer onto the bottle.
14. Use the magnetic pourer tool to open the pourer when pushing it into the bottle to release the pressure. If you don't, the pressure build-up will force liquid up the breather tube and air vent.
15. If you need more than one bottle with the same number, program as many pourers as needed.
16. Move on to the next brand and repeat.



PREFORMED SHRINK SEALS

Slide the heat shrinkable seal over the pourer. Turn the bottle as you apply heat to shrink the seal using a heat gun. The lower heat setting is hot enough to shrink the seals.



ELEVATED POURERS

Elevated pourers will be required for some tequila brands and scotches that have extra wide bottle necks.

The elevated pourer provides more room for the hand and insures that the pourer can be inserted completely into the ring.

The shrink seal available is not preformed. You have to align it so that it will shrink on top of the pourer base to hold the pourer in place.



POURER COVERS AND FRUIT FLY SCREENS

Optional pourer covers are available. When installed correctly on top of a pourer, the cover seals the air flow completely. We recommend using the covers on all the brands that have very high sugar content (sticky brands) as they will prevent the sugars (and cream) from crystalizing which will eventually lead to dispensing problems. The covers are very efficient at extending the period between cleaning as well. The pourer cover is useless when it is not on the pourer. It should go back as soon as the shot as been served.



The optional screened basket will pressure fit on top of the breather tube valve. It is designed to trap fruit flies that would have found their way inside the bottle. The basket can be removed and cleaned when fruit flies are seen in it.



BOTTLES WITH CHECK VALVES

Some brands are equipped with a check valve on top. The check valve has to be removed to insert a pourer into the bottle. To do so, you must first cut the liner installed on the bottleneck that holds the check valve in place. Then you can pry the valve out with a small screw driver.

It is a dangerous operation to use a utility knife. A slip of the blade could result in a serious injury. We recommend using a small rotary tool which is safe and much faster.

Leave the bottle cap on when you cut the liner.



POURER CLEANING

You should clean the pourer every time it is removed from an empty bottle.

If the pourer is on a very slow moving brand, the pourer should be taken off the bottle and cleaned on schedule every three weeks to prevent eventual dispensing problems.

Pourers should be taken off and cleaned if you do not plan to use the system for several weeks.

As you will empty a number of bottles every day, removing and cleaning pourers becomes part of the daily routine.

If a bottle is close to being empty, you should have another one prepared with a pourer on ready for the bartender.

It is a good idea to count the empty bottles taken out of the bar for inventory purposes.

Cleaning

1. Cut and remove the shrink seals and pull all the pourers off the empties.
2. Fill a bucket with hot water. The water has to be warm enough to melt sugar.
3. Leave the pourers to soak for 15 minutes.
4. Prepare your new bottles, heat gun, shrink seals and magnetic pourer tool.
5. After the soaking, use the magnetic tool to open the pourer and run hot water through the pourer for 10 seconds to rinse it. You will hear it click open.
6. Repeat for all.
7. Insert the pourer into the activator ring to see what brand it belongs to.
8. Use the magnetic tool to push the pourer into the new bottle.
9. Insert and shrink the seal.



*** DO NOT PUT THE POURERS IN A DISH WASHING MACHINE. YOU WILL DAMAGE THE POURERS!**

***STORE THE MAGNETIC TOOL OUT OF REACH FROM THE BAR STAFF WHEN FINISHED.**

POURER OPERATION AND TESTING

The pourer allows air to come in the bottle through the breather tube through a small intake hole located on top of the base of the pourer. Without air, liquid will not come out. The check valve at the end of the breather tube prevents liquid from coming out the air intake hole when the pourer is inverted and the valve closed. If the check valve is missing the pourer will not work well. The small stainless steel ball inside the check valve must move freely to work well.



The valve inside the pourer must also move freely. If the pourer is not used for a long period of time, the sugar contained in the alcohol will crystallise and impede the operation of the valve. This is why we recommend using the pourer cover for high content sugar product. The cover stop the air flow which will extend the time it takes for the sugars to dry. The cover is not an option if you want to use pourers on Irish Cream and the likes as the cream will block the outlet of the pourer within 24 to 48 hours.

The “Unblocking” feature of the system is designed to open the pourer in the upright position for ½ second to let the bartender know that the valve is operating normally before inverting the bottle to serve a drink. Should the bartender not hear or feel the valve open, he or she should not use the bottle and call the manager to have the pourer cleaned.

Should you want to test a pourer, you can do so after you have cleaned it. Fill a bottle with water and use the system to serve a drink. You should see air bubbles come out the breather tube as liquid comes out the pourer as about 10 ml (1/3 Oz.) per second.

PROGRAMMING

- To access the program modes, press and hold the **P1** button as you apply the manager's ibutton key onto the probe (1 of 6 ibutton).
- Remove the ibutton and release the **P1** button as soon as the **F** button light turns red.
- To get out of the programming mode, apply the ibutton key again.
- To change mode, press the **F** button once. You cannot go backward. To go back to a specific mode, press **F** until you have passed all the program modes.



MODE 1: PROGRAMMING THE POURER NUMBERS

- Insert a pour into the ring
- Press the P3 button to read the programmed code.
- Move the cursor using the < and > buttons.
- Press P1 to increase the pourer number.
- Press P2 to decrease the pourer number.
- Press P4 to program the number into the pourer.
- Repeat for as many pourers as you need.

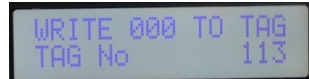

WRITE 000 TO TAG
TAG No 113

MODE 2: POUR SIZE TIMER

A TIMER setting of 32 equals approximately 1oz (30ml). Products with a higher viscosity will take more time to serve.

- To view a different code and size press the **arrow buttons** to move up and down.
- Pour a drink into a graduated cylinder.
- Measure the volume of the drink poured.
- Press the P3 button to increase the timer value.
- Press the P4 button to decrease the timer value.
- Press **F** to skip to the next mode.

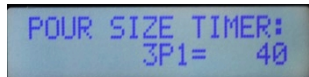

POUR SIZE TIMER:
3P1= 40

MODE 3: COPY TIMER SETTINGS

- Press the **arrow buttons** to move up and down to change the pourer number.
- Press the P4 button to copy the timer values you have just set to all the pourers.
- Press **F** to skip to the next mode.

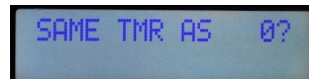

SAME TMR AS 0?

MODE 4: POS AND REGISTER INTERFACE

If you are using the Liquor Manager Live software with POS interface, press the arrow buttons and select the Auper protocol. If you do not interface your Eclipse to a POS or a cash register, make sure the system is set to POS **DISABLED**.



- Press **P4** to set the POS interface to Enabled/Disabled.
- Press the arrow buttons to change the protocol.
- Press F to skip to the next mode.

The next modes only apply when the interface feature is set to enable. Go directly to the serial port setting section.

Protocols available:

The following modes are available if POS Interface is set to Enabled.

- (1) Auper
- (2) Berg generic
- (3) Berg basic
- (4) Veloce Brand ID
- (5) Micros NALDS
- (6) IR scanner emulation
- (7) Micros ILDS

PLU table

The default factory PLU table can be changed using the Liquor Manager software.

POURER NO.	P1	P2	P3	P4
0	1000	2000	3000	4000
5	1005	2005	3005	4005
60	1060	2060	3060	4060
125	1125	2125	3125	4125
255	1255	2255	3255	4255

Default PLUs: First digit shows the pour size number (1 to 4). Last three digits show the pourer number.

MODE 5: POS TIME OUT (INTERFACE SET TO ENABLED ONLY)

Sets the time your liquor system will wait for a reply from your POS system after a pour request has been sent. This timer is necessary to prevent the liquor system from waiting indefinitely in case the POS reply did not come.

- Press the **P1** button to decrease this value.
- Press the **P2** button to increase this value.
- Press **F** to skip to the next mode.

**MODE 6: PLUS FORMAT (INTERFACE SET TO ENABLED ONLY)**

You can select the format of the PLUs sent by the Eclipse to the POS. For example: PLU 0651

If the 4-digit PLUs is set to Y: the PLU will be sent as is 0651.

If the 4-digit PLUs is set to N: the PLU will be sent as 651 only.

- Press P4 to select between Yes or NO.
- Press **F** to skip to the next mode.

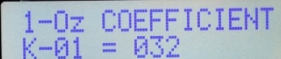
MODE 7: 1-OZ COEFFICIENT

Coefficients have already been assigned to the product names in the database contained in Liquor Manager software. A coefficient (K) is the value of a timer to serve 1 Oz. (30ml) of a product with a given viscosity. For regular products, K1 is set to 32. The value of a coefficient increases with the viscosity. We have determined 4 coefficients:

- 32 for regular products
- 35 for half sweetened products
- 38 for sweetened products
- 45 for creams

The viscosity coefficients are used by the Liquor manager software to calculate the pour size timers based on the shot size entered for each pour size button.

If you don't want to change the factory settings of the Eclipse system, skip to the next mode by pressing the **F** button (Recommended).

You can use this mode to measure the coefficient value of a specific product or if you plan on using a different shot size.

- Insert the bottle in the ring
- Press the < button to reset the coefficient value.
- Invert the bottle over the shot glass.
- Press the > button to open the pourer.
- Press the > button again to close it when you reach the 1 Oz. (30ml) mark.
- Press the **P3** or **P4** button to change the value manually.
- The coefficient value will move up until you close the pourer.

You can modify coefficient in the Liquor manager database. The software will re-calculate the pour size timers. You will need to reprogram the system to apply these changes in the Eclipse.

MODE 8: PC COM PORT SELECTION

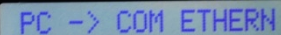

- Press the < and > buttons to alternate between COM Ethernet, COM RS232 and COM RS422.
- If you are connecting the Eclipse to the network, set it to COM EHTERNET.
- If you are connecting the Eclipse to a PC using the RS232 serial port, set to RS232.
- If you are connecting one or more Eclipse systems using the RS422 port, set to RS422.
- If you are not using a PC, Press **F** to skip to the next mode.

MODE 9: POS COM PORT SELECTION



- Press the < and > buttons to alternate between COM Ethernet, COM RS232 and COM RS422.
- If you are interfacing the Eclipse to a POS terminal or cash register using the RS232 serial port, set to RS232.
- If you are interfacing one or more Eclipse systems using the RS422 port, set to RS422.
- If you are not interfacing your system to a POS, Press **F** to skip to the next mode.

MODE 10: PRINTER COM PORT SELECTION

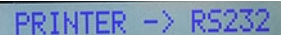

- Press the < and > buttons to alternate between COM Ethernet, COM RS232 and COM RS422.
- If you are connecting the Eclipse to a serial printer using the RS232 serial port, set to RS232.
- If you are connecting one or more Eclipse systems to a serial printer using the RS422 port, set to RS422.
- Press **F** to skip to the next mode.

Multiple port configurations:

You can connect the Eclipse to the network to use the Liquor manager software to maintain and program the settings of your liquor dispenser(s) and use the COM port to either interface the system to a POS system or to print usage reports on a serial printer at the bar. There is only one baud rate setting on the Eclipse. If you use multiple peripherals, they must all be set to work at the same baud rate.

MODE 11: BAUD RATE

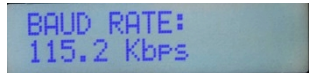

- Press the < and > buttons to choose the baud rate with which you will communicate with the PC, POS or printer. (Between 2400 bps, and 115.2 kbps. There is only one baud rate setting for all.
- Press **F** to skip to the next mode.

MODE 12: PRICE SETTING



The prices are usually set using the software and then uploaded in the Eclipse. You can change the price setting for each pourer code and pour size using this mode but it will not change it automatically in the software. You should update your system settings in the software immediately after.

- Move the cursor using the < and > buttons.
- Press the P1 button to move up and the P2 button to move down the pourer number and size.
- Press P3 and P4 to increase or decrease the digit value (0 to 9).
- Press **F** to skip to the next mode.

MODE 13: COPY PRICE SETTINGS

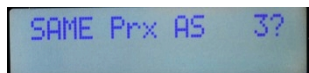

This mode can be used if all the products and pour sizes dispensed by the Eclipse are sold at the same price.

- Press the < and > buttons to change the pourer number.
- Press P4 to copy the price values you have just set to all the pourers.
- Press **F** to skip to the next mode.

MODE 14: SYSTEM NUMBER



You will use the system number to identify the Eclipse system either on printed reports or with the Liquor Manager software. System numbers can be set between 0 and 99. You cannot have two Eclipse systems with the same number on the network.

- Press P3 and P4 to increase or decrease the system number.
- Press **F** to skip to the next mode.

MODE 15: DEFAULT POUR SIZE

This option sets the system to return to a specific pour size automatically a few seconds after it has been used. The delay to return to a specific pour size after removing the pourer from the ring can be set between 0.5 and 8 seconds. The next program mode will be available if this option is set to Enabled.

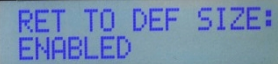

- Press the P4 button to change between Enabled and Disabled.
- Press **F** to skip to the next mode.

MODE 16: DEFAULT POUR SIZE DELAY

- Press P3 and P4 to increase or decrease the delay.
- Press **F** to skip to the next mode.



MODE 17: SETTING THE DEFAULT POUR SIZE

- Press the pour size button that you want the system to return to automatically.
- Press **F** to skip to the next mode.

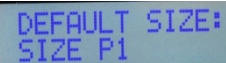

MODE 18: MANAGER KEYS

You can enter up to six manager keys in your system. Each key should be identified as Manager 1 to 6 on the plastic fob. The electronic code is etched on each key. You can view each key number in this mode. When a key number is not programmed, zeros will be displayed.

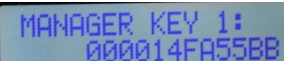

- Press the < and > buttons to scroll through the manager keys list.
- Press **P3** to delete a key.
- Apply the new i-button key to the sensor. The code will be displayed with **NEW** in front of the code.
- Press **P4** to accept an assign the manager key.

Should you lose power to the system before you have assigned a new manager key, upon power up, the system will display the following message: PLEASE PUT MANAGER KEY AND PRESS P4 TO SAVE

- Press **F** to skip to the next mode.

MODE 19: QUICK POUR MODE

When the Quick pour mode is disabled, the system will complete the current pour size before you can shake the ring to start a new one.

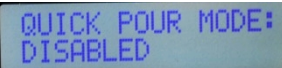

If the Quick pour mode is enabled, you can interrupt a pour size and start a new one by shaking the ring.

In both cases, the system will count 1 for each pour size activated (even interrupted ones).

- Press **P4** to enable/disable
- Press **F** to skip to the next mode.

MODE 20: AUTO-POUR MODE

When the auto-pour mode is enabled, you can pour several shots automatically by leaving the bottle inverted. A new pour size will start after the programmed delay.



- Press **P4** to enable/disable
- Press **F** to skip to the next mode.

MODE 21: AUTO-POUR DELAY

You can program the delay between pour sizes from 1 to 4 seconds in increments of 0.5 seconds. You can try the system in this mode to see if the selected delay suits you.

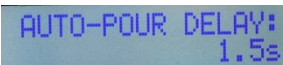

- Press **P3** and **P4** to increase or decrease the delay.
- Press **F** to skip to the next mode.

MODE 22: UNBLOCKER OFF/ON

The “Unblocker” feature serves to open the pourer for ½ second with the bottle still in the ring holder. Its purpose is to warn the bartender to not use the bottle if he or she does not hear or feel the pourer opens.

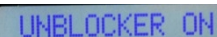

- Press **P4** to alternate between ON or OFF
- Press **F** to skip to the next mode.



Mode 23: Print CKT TABLE (OBSOLETE)

This mode will be removed in the next revision of the system’s program.

MODE 24: SAVE SETTINGS

Your settings will be transferred into an independent memory chip. Should we need to re-initialize your systems microprocessor or clear the memory, we will be able to reload your system settings. This operation will be performed with the help of a trained and qualified technician.

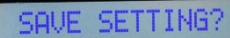

- Press the P4 button to save your settings.
- Press F to skip to the next mode.

MODE 25: FIRMWARE VERSION

Identifies the CPU and firmware running your Eclipse system.



- Apply your manager ibutton key to exit the program mode.
- Press F to go to mode No.1

RUN MODE

Use this mode to pour drinks

- Select the pour size using the **P1 to P4** buttons.
- Insert a bottle with a coded pourer into the activator ring. The blue light indicates that the system is ready to pour.
- Invert to pour.
- When the first pour ends, give the inverted bottle a quick shake. Repeat as many times as necessary.
- If the auto pour restart function has been enabled, wait with the ring inverted until the next pour starts. A delay of 2.0 seconds is programmed by default at the factory.
- Press F to skip to the next mode.

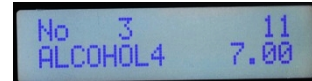

PRINT TICKET

You can use this mode if you use the Liquor manager Live software.

When you press P4, the Eclipse sends a request to the software to print a current bar balance report to the bar network printer configured to print these reports.

- Press F to skip to the next mode.

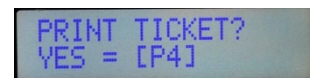

READING THE COUNTERS FROM THE DISPLAY

- Press the < and > buttons to scroll through the pourer numbers and pour sizes.
- Press the P3 to come back to the first counter.
- Press F to skip to the next mode.

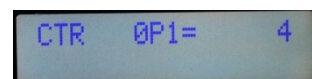

PRINT REPORTS

Reports are numbered and identify the Eclipse system number.

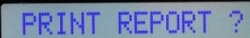

- Press P4 to start printing.
- After the report is printed, the system will ask you if you want to clear the counters.
- If **no**, Press F to skip to the next mode.
- If **yes**, apply a manager i-button key to the probe



SYSTEM ENABLED

A manager can disable the system to prevent people from using it.

- Apply a manager ibutton key to disable the system. The F button light turns RED.
- Apply a manager ibutton key to re-enable the system.
- Press F to go back to the run mode.

SERIAL CONNECTORS

Two serial ports are available on the Eclipse 4250.

RS-232 AND RS-422

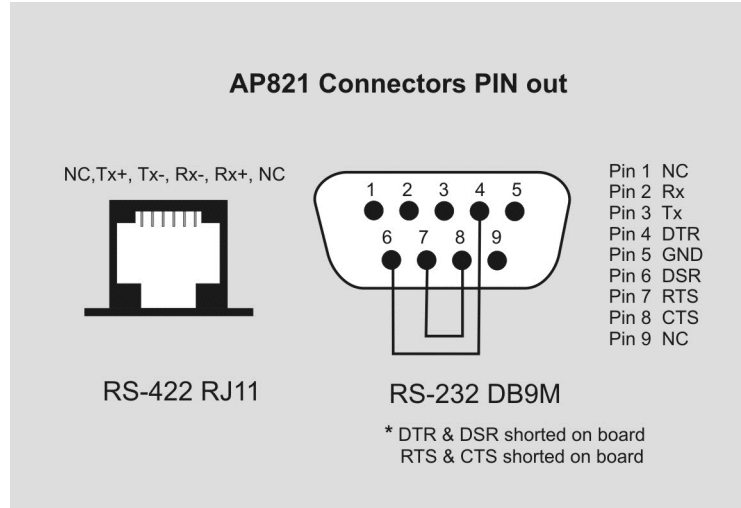

RS-232 NULL MODEM:

You should not exceed **150 ft (50 M)** with a RS-232 cable. Use a Cat 5 cable terminated with RJ45 to db9 FEMALE shell connectors for runs longer than 30 ft.

For short cables, use part 70-010 (3 M/10ft).

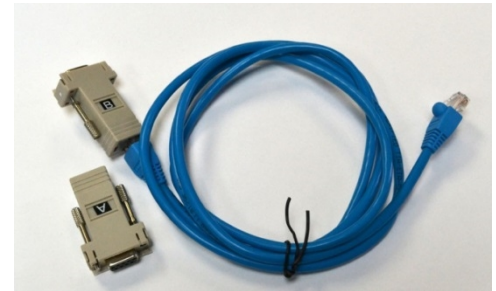

If you make your own cable, please refer to the pin out below.



RS-232 null modem cable

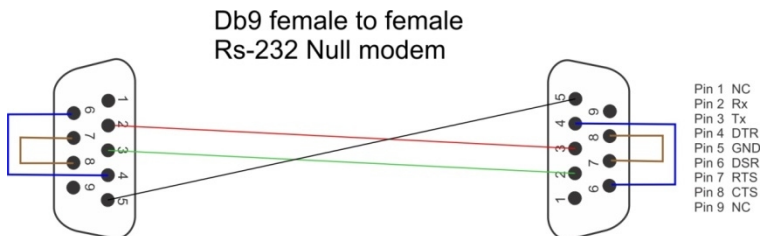

USB TO SERIAL CONVERTER

Most computers are not be equipped with 9-pin serial ports. A USB to serial adapter will be needed. Drivers are provided with the converter and must be installed on the computer. Windows will assign the serial port automatically. You can see to which port your converter has been assigned at:

Control panel/system/device manager/ports (Com & LPT)

The defaults Windows serial port settings are:

9600 bps, 8 bits, no parity, 2 stop bits and no flux control.

CONNECTING THE ECLIPSE TO A COMPUTER

You can connect one Eclipse directly to your PC using a serial null modem cable.

CONNECTING THE ECLIPSE TO A POS OR CASH REGISTER

Interfacing an Eclipse to a POS is achieved using the RS-232 serial port. You can connect your Eclipse to your POS or cash register using a RS-232 null modem cable (P/N: 70-030). Some registers require a gender changer connector.

Set the RS-232 port to POS. (See programming)



RS-422 SERIAL PORT CONNECTIONS

You will use the RS-422 port for the following reasons:

- You wish to connect your Eclipse system to a computer more than 150 ft (50M) away.
- You have more than one Eclipse that you want to connect to the same computer, POS or serial printer.



Use inverted RS422 twisted pair cables between the Eclipse and the AP821 converter (P/N: 70-042-X).

When using the RS-422 port, you will need to convert the signal back to RS-232 before you can connect your cable to a computer, POS or printer. The AP821 converter has a built-in RS-232 port.

Liquor Manager Live Installation Overview

The Liquor manager Live software will be installed by a factory trained technician. Most times it is done by remote access using the Internet. The software must be installed on a Windows computer that is on the same network as your POS system if we are to interface the POS with the liquor systems. Once the software has been installed, the technician will use the software to find the liquor systems connected to your computer network and set them to log in the Liquor manager software.

To configure your liquor systems, we will have requested that you send us the following:

- List of brands to be used with the dispenser
- Portion size needed for each brand
- Selling price for each brand and portion size
- Drink recipes for all mixed cocktails and shooter that you have on your POS menu

Once the software has been installed and communication with the Eclipse systems verified, the technician will install your configuration user files that has been programmed in your systems.

Ticket Printer

If you have ordered the optional ticket printer to be able to print Liquor Manager Live bar reports at the bar, the technician will configure the network address and test the printer.

Live POS Interface

The POS system will then be set up to send the drinks ordered by your staff to our POS server. The menu items will be verified and the drink recipes uploaded in our software database.

Once everything is finally configured, the drinks served and the drinks rung in the POS system will be time stamped and match against each other Live. POS error and unregistered sales will be factored in the balance report which will be emailed to you automatically at the end of each shift.

Quality - Precision - Durability



Auper Electronic Controls Inc
3065 Monte St-Aubin
Laval, Quebec
Canada, H7L 4E4
Phone: 1.450.663.1993
Toll free: 1.800.861.1620
Fax: 1.450.663.0636
E-Mail: info@auper.com

Manufacturer of quality control systems since 1985.